

防止石礦及建築工人患上矽肺病的指引

**Guidance Notes on Protection of Quarry and
Construction Workers from Silicosis**

本指引由勞工處職業安全及健康部印製

This guide is prepared by the Occupational Safety and Health Branch
Labour Department

2000 年

9 月版

This edition

September 2000

本指引可以在職業安全及健康部各辦事處免費索取。有關各辦事處的詳細地址及電話，請參閱由本處印製的「勞工處為你提供各項服務」小冊子或致電 2559 2297 查詢。

This guide is issued free of charge and can be obtained from offices of the Occupational Safety and Health Branch. Addresses and telephone numbers of the offices can be found in the booklet "The Labour Department Offers You Its Services" or by telephone 2559 2297.

目錄

Contents

頁數
Page

緒言	1
Introduction	
指引的目的	1
Aim of Guide	
僱主的責任	2
Duties of Employer	
僱員的責任	2
Duties of Employee	
矽肺病的症狀	3
Description of Silicosis	
評估工作上對健康有害的因素	4
Assessment of Health Hazards at Work	
矽石塵的衛生標準	4
Hygiene Standards for Silica Dust	
資料、指示及訓練	4
Information, Instruction and Training	
塵埃的控制	5
Dust Control	
通風系統	6
General Ventilation	
個人呼吸防護設備	7
Personal Respiratory Protection	
環境監察	8
Environmental Monitoring	

從事開採石礦及建築工作而吸入塵埃的人士所需的醫療檢驗	8
Medical Supervision of Persons Exposed to Dust in Quarry and Construction Work	
附錄一 – 結晶矽石塵的職業衛生標準	9
Appendix I-Occupational Exposure Limits for Dust Containing Crystalline Silica	
附錄二 – 工場塵埃量檢定	11
Appendix II - Workplace Dust Monitoring	
附錄三 – 空氣監察記錄樣本	13
Appendix III - A Sample Record of Air Monitoring	
附錄四 – 體格檢驗記錄樣本	14
Appendix IV - A Sample Record of Medical Examination	
附件 – 工序中塵埃控制的應用	15
Annex - Application of Dust Control to Processes	
進一步資料	32
Further Information	

緒 言

開採石礦或與石礦有關的大部份工序例如鑽石、爆石、切石、碎石及粒料製造等都會產生塵埃，使工場內空氣污染到達危險程度。這種情形亦會在整理地盤、建造地基、沉箱、挖掘隧道和處理建造業石質產品時出現。香港岩石含硅石(矽土)量很高，因此，吸入石粉的人士，很易患上矽肺病。在香港，這種疾病的患病率頗高，而患病者又以石礦及建造業工人居多，因此應倍加留意及採取有效行動加以預防。

指引的目的

本指引的目的是提醒有關人士留意矽塵的危險，並告知其應採取的安全工作方法，以保障石礦及建築工人免受矽塵侵害，引致矽肺病。

本指引適用於任何會產生結晶硅石塵以致工人因吸入此種塵而健康受損害的石礦或建築地盤工作。實際上，這是泛指一切石礦工作及建築業各種產生塵埃的工作，例如整理地盤、挖掘隧道、沉箱及其他涉及鑽石或碎石的工作。

Introduction

Most of the processes in quarrying and the associated activities of rock drilling, blasting, stone cutting, rock crushing and aggregate manufacture generated dust which can cause dangerous levels of airborne contamination in the workplace. The same applies to site formation, foundation, caisson and tunnelling activity and the handling of rock products in the construction industry. Local rock has a high silica content which makes silicosis the major health hazard of exposed persons who inhale the dust. The incidence of the disease is high in Hong Kong, especially among quarry and construction workers and prevention deserves particular attention and action.

Aim of Guide

The aim of this Guide is to draw attention to the hazard and advise on the measures necessary to achieve safe practice and protect quarry and construction workers from dangerous dust exposure and the special health hazard of silicosis.

This Guide applies to work in quarries or construction sites which expose persons to health hazards from inhalation of dust containing crystalline silica. In practice this means all quarrying work and all dust-generating activities in the construction industry such as site formation, tunnelling, caisson and other rock excavation work involving drilling, breaking or crushing.

僱主的責任

僱主有責任確保僱員在工作時，健康不會受到損害，並須採取所有可行的預防措施 – 請參閱工廠及工業經營規例第三十三條。

僱員的責任

僱員有責任正確地使用有關的設備（包括個人防護設備，例如防塵面罩等），藉以保障健康 – 請參閱工廠及工業經營規例第二十一條。

Duties of Employer

The employer is responsible for ensuring that he protects his employees from health hazards at work and should take all practicable measures necessary - Regulation 33 of the Factories & Industrial Undertakings Regulations refers.

Duties of Employee

The employee is responsible for making proper use of equipment including personal protection devices such as dust masks when these are necessary and provided for safeguarding health - Regulation 21 of the Factories & Industrial Undertakings Regulations refers.

矽肺病的症狀

矽肺病（亦稱石灰肺病或硅肺病）是由於吸入含矽石（矽土）的粉塵而起。這些粉塵能深入肺部，侵襲肺氣泡，使肺部功能逐漸損壞。通常工人是在吸入矽塵數年後病徵才會出現，但是亦有短至六個月的接觸時間者。初期的症狀是在勞動時覺得呼吸緊促。當病況加深時，呼吸將更緊促，甚至在休息時亦會如此，因而不能作日常活動。在患病初期，胸部X光檢查對斷症有很大幫助。目前此病仍未有特別治療方法，但如果能使患者不再吸入矽石塵，將可防止其肺部受進一步的損害。

Description of Silicosis

Silicosis is caused by the inhalation of fine particles of dust containing free silica. The dust penetrates deep in the lungs where it attacks the tissues and causes progressive deterioration of pulmonary function. The onset of the disease is usually after some years' exposure to silica dust, although exposure time as short as six months have been reported. The first symptom is shortness of breath on exertion. As the illness progresses, the breathlessness becomes worse appearing even at rest and prohibiting normal activity. Chest X-rays are an important aid to diagnosis in the early stages. There is no specific treatment but progressing lung damage can be largely prevented by removing the affected person from further silica dust exposure.

評估工作上對健康有害的因素

如某種工作可能令人的健康受損，則僱主應評估該類工作對健康造成損害的性質及程度，以便採取適當的預防措施。

硅石塵的衛生標準

在評估吸入塵埃量時，宜採用附錄一詳述的各類結晶硅石塵的「職業衛生標準」。

資料、指示及訓練

所有僱主應確保其僱員獲得適當的資料、指示及訓練，從而認識到損害健康的因素及所應採取的預防措施。

Assessment of Health Hazards at Work

Where work may expose persons to health hazards the employer should have the nature and degree of the exposure determined with the object of ensuring that appropriate preventive measures are taken.

Hygiene Standards for Silica Dust

In assessing exposure to dust the Occupational Exposure Limits for Dust Containing Crystalline Silica as detailed in Appendix I should be applied.

Information, Instruction and Training

Every employer should ensure that adequate information, instruction and training are given to his employees so that they are aware of the health hazards and the precautions necessary for prevention.

塵埃的控制

工場內所有產生塵埃的工作均應加以評估，以確定最有效的措施去減低空氣中的塵埃所造成的污染。一般的控制方法包括將工序密封、使用抽氣系統或用水、泡沫或油灑濕塵埃，以將塵埃減少。管方應向廠內或外界專業人士查詢有關資料，以便為現有的機器選擇適當的控制措施；此外並在購置新機器時，應將塵埃控制列為先決條件。

所有控制塵埃的設備應有完善保養，以確保其有效操作，同時應進行定期檢查，並將紀錄保存。

在附件，列載了多種工序的控制方法，例如岩石鑽孔等。但該附錄祇應視作一般性指南。在特別情形下，應徵詢有關專業人士的意見。工程師在設計塵埃控制系統時，應同時指定測試該系統運作效能的方法。由塵埃收集系統收集得的塵埃須以安全方法處理。

Dust Control

All activities which generate dust in the workplace should be assessed to determine the most effective means of reducing airborne dust pollution. Control is usually achieved by enclosure, exhaust ventilation systems or wet suppression methods by water, foam or oil. Management should secure either from internal or external sources the necessary expertise to select the appropriate control methods for existing machines and dust control should be a priority specification in ordering new machinery.

All dust control equipment should be properly maintained to ensure effective functioning. A regular inspection system should be instituted and all the maintenance records are kept for future reference.

Ways on the application of control methods to certain processes such as rock drilling are given in the Annex. However, these should be regarded as a general guide only. Advice as required in specific circumstances should be sought from appropriate sources with the necessary technical expertise. In designing a dust control system, the engineer should also specify the method to test the effectiveness of the system after installation. All dust collected by a collection system must be disposed of in a safe manner.

通風系統

應採取一切所需措施，確保工場內獲得足夠的新鮮空氣，環境令人滿意。如天然的通風情況不佳，應由具資格人士設計及安裝人工通風系統，並定期檢查其效能。在密閉場地例如沉箱及隧道內工作時，尤需特別注意通風裝置。在後者而言，應參考另一本刊物「防止隧道工人患上矽肺病的工作守則」，該守則是特為隧道工作而編寫。

General Ventilation

All necessary steps should be taken to ensure that sufficient fresh air is available in the workplace to provide an acceptable environment. When natural ventilation is not adequate, artificial ventilation systems should be designed and installed by competent persons and their efficiency regularly checked. Ventilation arrangements may need particular attention when work is conducted in confined spaces such as caissons and tunnels. In the latter case reference should be made to a guidebook on "Code of Practice for Protection of Tunnel Workers from Silicosis" which refers specifically to tunnel work.

個人呼吸防護設備

控制塵埃的來源處是避免健康受到危害的基本措施，但倘若此項方法不能有效限制空氣中的塵埃量，便應在遇有危害健康情況時，提供及佩戴個人呼吸防護設備。

應按塵埃量及種類選擇適當的防護設備，並須特別注意此等設備的存放、保養及清潔。所有呼吸防護設備的效能應足以防止佩戴者吸入零點五至五微米的塵粒。工人須獲得指導，懂得如何適當使用此等設備及試驗其能否完全緊蓋面部。

Personal Respiratory Protection

The primary measures for preventing health hazards should be directed to control of dust at source but if such action cannot effectively limit airborne dust level, respiratory protection equipment should be provided and worn while the hazard is present.

Appropriate equipment should be selected to protect against the specific form and level of dust hazards which prevail and particular attention should be paid to the storage, maintenance and cleaning of the equipment. All respiratory equipment provided should be capable of preventing the wearer from inhaling dust particles ranging from 0.5 to 5 microns. Workers using such equipment should be instructed of the proper use and the test for good fitting of the face seal.

環境監察

為着評估塵埃對健康的危害及各項預防措施的效能，應最少每半年監察工場內的塵埃量。

監察空氣時應依照附錄二所載細則進行。此外，抽樣查驗及結果之詳情應填寫於附錄三所載的「空氣監察紀錄」表，以便有關當局審閱。

從事開採石礦及建築工作而吸入塵埃的人士所需的體格檢驗

因從事開採石礦及建築工作而吸入塵埃的僱員應每年接受體格檢驗，包括照射一張胸肺X光（硬）片。

負責檢驗的醫生應在進行體格檢驗後，填寫指定的報告表格（樣本見附錄四），並將一份送交勞工處職業健康服務審閱。

Environmental Monitoring

In order to assess health hazards and evaluate the continuing effectiveness of prevention measures, dust levels in the workplace should be monitored at least half-yearly.

Air monitoring methods should follow the guidelines outlined in Appendix II. Records should be maintained with details of sampling and results using the "Record of Air Monitoring" form as shown in Appendix III, for ease of inspection by the Authority.

Medical Examination of Persons Exposed to Dust in Quarry and Construction Work

Persons employed in quarry and construction work which exposes them to dust should undergo medical examination which includes a full plate chest X-ray each year.

The examining medical practitioner should complete the prescribed report form (specimen at Appendix IV) and send a copy to the Occupational Health Service of Labour Department.

結晶矽石塵埃的職業衛生標準

- 一 儘可能減少吸入塵埃。
- 二 任何人在值班時吸入的塵埃量均不得超過每日工作八小時的職業衛生標準(OEL-TWA)。
- 三 矽石的結晶類有多種。其中以石英在香港為最常見的類別。其他如方石英和鱗石英亦可能見於建築材料中。矽石塵埃的職業衛生標準是以「可吸入微塵量」的「時量平均值(TWA)」來計算。現定下的職業衛生標準(OEL-TWA)詳列如下：

Occupational Exposure Limits for Dust Containing Crystalline Silica

- 1 Exposure to dust should be reduced to the minimum that is reasonably practicable.
- 2 In any case exposure of any person to dust averaged over a shift should not exceed the occupational exposure limit (OEL-TWA) for an 8-hour working day.
- 3 There are several forms of crystalline silica. Quartz is most abundant and commonly found in Hong Kong. There are two others, namely cristobalite and tridymite which may also be encountered in building materials. The occupational exposure limits for the crystalline silica (respirable dust) are listed in the following:

結晶矽石 (可吸入微塵量) Crystalline Silica (respirable dust)	職業衛生標準時量平均值 (毫克/立方米) OEL-TWA (mg/m ³)
方石英 Cristobalite	0.05
石英 Quartz	0.1
鱗石英 Tridymite	0.05

- 四 倘值班時間與八小時明顯不同，必須按比例調整衛生標準，以確保工人有足夠的保障，這類調整應先諮詢專業人士的意見。
- 五 有關職業衛生標準的說明及使用指引，可參閱勞工處出版的小冊子 - 「工作環境內化學品的職業衛生標準參考資料」。
- 4 Where the duration of a shift is markedly different from 8 hours, the OEL-TWA should be adjusted by a suitable factor to ensure adequate worker protection. Expert advice should be sought in such modification of occupational exposure limits.
- 5 Interpretation and guidance in the uses of occupational exposure limits are available from "A Reference Note on Occupational Exposure Limits for Chemical Substances in the Work Environment".

工場塵埃量檢定

方法

- 一 測量空氣中的塵埃量及含結晶矽石量的方法是根據體積選擇塵埃抽樣法及繼而採用適當分析技術進行。
- 二 抽樣儀器附有合適濾片及氣泵，在八小時或適當的指定抽樣時間內以校定之速度抽入空氣。而塵埃含結晶矽石量則以紅外線分光光度法或X光繞射法測定。

輔助服務

- 三 勞工處職業環境衛生科可按個別工作環境，提供有關合適設備、抽樣及化驗方法的意見。

Workplace Dust Monitoring

Methods

- 1 The method of measuring the airborne respirable dust and its crystalline silica content is based upon size-selective dust sampling followed by suitable analytical techniques.
- 2 A sampling instrument is equipped with suitable filters and a pump to draw air through at a set rate for an 8-hour or appropriate sampling period. The level of crystalline silica dust is determined by infrared spectrophotometry or X-ray diffraction.

Support Service

- 3 Advice on suitable equipment, sampling strategy and analytical methods to suit particular work circumstances is available from the Occupational Hygiene Divisions of the Labour Department.

圖一：可吸入微塵的抽樣儀器

Figure 1: Sampling equipment for respirable dust

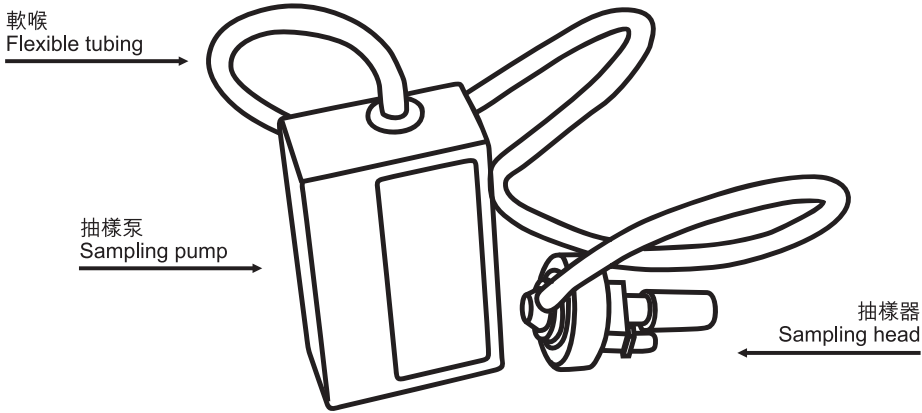

空氣監察記錄樣本
A Sample Record of Air Monitoring

公司名稱

Name of Company: _____

公司地址

Office Address: _____

電話

Tel: _____

地盤地址

Site Address: _____

電話

Tel: _____

測量日期

Date of Measurement: _____

抽樣氣泵

Sampling Pump: _____

測量工作由

Measurements performed by: _____

執行

抽樣器

Sampling Head: _____

樣本 編號 Sample Serial No.	抽樣類別 (固定／個人) Type of Sampling (Static/Personal)	操作性質/ 工人姓名 Operation/ worker sampled	流量 (升 / 每 分鐘) Flow rate (L/min)	抽樣 時間 Sampling time	可吸入矽石塵 之重量 (毫克) Respirable silica (mg)	塵埃濃度 (毫克 / 立方米) Dust Conc. (mg/m ³)	八小時平均值 (毫克 / 立方米) 8hr-TWA (mg/m ³)

體格檢驗記錄樣本

A Sample Record of Medical Examination

公司名稱

Name of Company: _____

公司地址

Office Address: _____

電話

Tel No.: _____

地盤地址

Site Address: _____

電話

Tel No.: _____

編號 Serial No.	姓名 Name	身份證號碼 HKID No.	照肺檢驗日期 Date of Chest Radiographic Examination	檢驗結果 (包括照肺檢驗報告) Results of Exam including chest X-ray exam report

備註：如果經醫生診斷為矽肺病，須按照國際勞工組織U/C國際分類法，在報告內列出患上肺塵埃沉著病之等級。

Note: If silicosis is diagnosed, the report should include classification of the grade of pneumoconiosis using the ILO U/C International Classification.

醫生姓名

Name of Medical Practitioner: _____

簽名

Signature: _____

地址

Address: _____

日期

Date: _____

工序中塵埃控制的應用

緒言

- 幾乎所有開採石礦和整理建築地盤工程都會產生塵埃，其中鑽孔、碎石、篩石、運送、混合及儲存等工序尤須施行塵埃控制。控制方法可根據不同工序而採用抽取、抑制、圍封或密封等辦法。設計方面由於受到很多因素影響，因此不可能設計一套適用於任何情況的系統。以下概述了各種工序的一般塵埃控制方法。

Application of Dust Control to Processes

Introduction

- 1 Almost every operation in quarrying and in site preparation in construction produces dust and among those requiring some form of dust control are drilling, blasting, breaking, loading, hauling, crushing, screening, conveying, mixing and storing. Control is achieved by using a suitable method of extraction, suppression, enclosure or encapsulation to match the process. Many variables influence the design detail in each case and exact specification of system planning to cover all conditions is not possible. However the general application of control to various processes can be considered under the following outlines.

圖二：塵埃的控制系統

Figure 2: Dust control systems

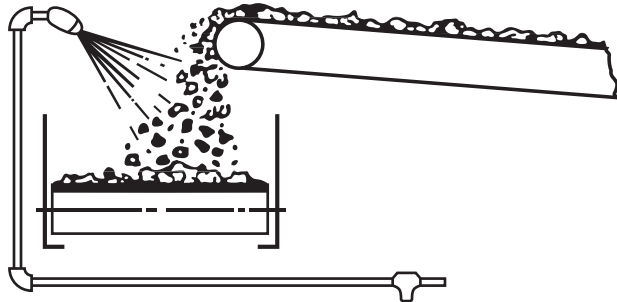
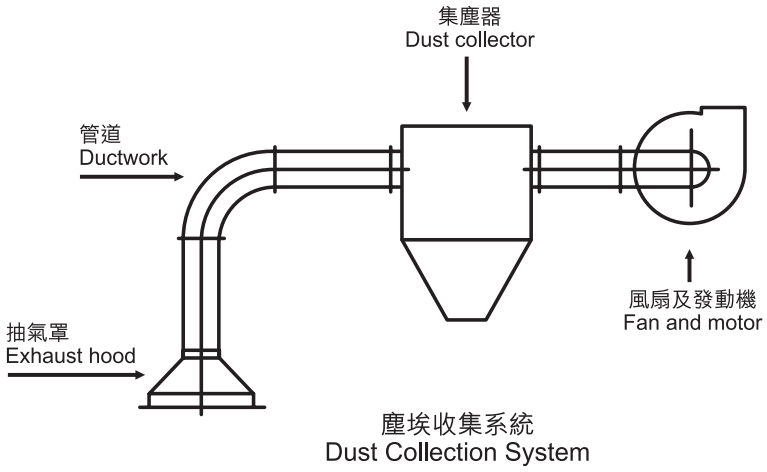

岩石鑽孔

- 二 以手動氣鑽或鑽機架進行岩石鑽孔工作時，大量塵埃會從鑽孔噴散，這顯然嚴重危害操作員及工作環境內其他人士的健康。因此鑽機須裝置適當的抽氣系統，從鑽頭的塵罩抽取的塵埃通常會被送到旋風式集塵器及濾袋收集。此外，鑽機架亦可使用標準洒水設備，去抑制鑽孔點所散發的塵埃。

爆石

- 三 用鑽粉料填塞鑽孔是通常的做法。此舉在爆石時，總會引致大量粉塵爆射到空氣中。這種做法應予以取替。採用十毫米碎石去堵塞鑽孔是較佳的方法。

Rock Drilling

- 2 During rock drilling either by hand-held drill or drilling rig, dust is discharged from the drilled hole in large volume causing considerable health risk to the operator and others in the work environment. A suitable local exhaust system should be fitted with the hood round the drill collar trapping dust which is passed through a dust collection unit usually consists of a cyclone followed by a bag filter. Alternatively drilling rigs can use a water spray method to secure dust suppression at the drilling point as a standard fitting.

Blasting

- 3 It is a common practice to use drill fines to stem blast holes. This will invariably result in large volumes of fine dust being ejected into the atmosphere. This practice should be discouraged. Aggregates (10 mm) are recommended to be used for all blast hole stemming operation.

碎石工序

- 四 在初級碎石工序中很難避免產生塵埃，因為倒石的地方及機器的入料口必須保持開啟。初級碎石機可被三面圍封，而沒有圍封的一面應安裝橡膠遮帘以減少塵埃飛揚。為減少入料時產生大量塵埃，可在碎石機入口上方裝置洒水設備。中央控制室必須裝上適當的通風設備，保持室內不受塵埃污染，使操作員可在合宜的環境內工作。碎石機的碎石排出口亦應裝上洒水設備或加以密封。此外在運走碎石的輸送帶上也可安裝局部抽氣設備。
- 五 一般來說，在使用次級、三級或其他旋轉碎石機時，密封是最有效控制塵埃散播的方法。碎石機器通常裝有斜槽或入料口，方便傾注物料，而與其他部份一樣，入料過程均可予以完全密封。如使用顎形碎石機或磨石料的機器，由於不能予以完全密封，可加設抽氣罩，以獲致近乎完全密封之效果。

Crushing Processes

- 4 The containment of airborne particles in the primary crushing process is difficult. Access must be available for dumping and the feed opening of the machine by necessity has to be uncovered. Primary crushers can be partially enclosed by a three-sided building. To prevent dust spreading to surroundings a rubber curtain should be attached to the open side and to help suppress the dust generated during feeding, a wet suppression system may be installed above the crusher intake. An adequately ventilated, dust free, control cabin should be provided to provide acceptable conditions for the operator. Discharge from the crusher can be controlled by wet suppression or preferably encapsulation. Local exhaust may also be provided to the conveyor which extracts the crushed material.
- 5 Encapsulation is generally the best method of control for secondary, tertiary and other gyratory crushers. Usually the feed to these machines is by means of a chute or conveyor which extracts selected material from primary surge piles or storage bins, and with most units total enclosure of the feed arrangement can be achieved. Jaw crushers or granulator type machines if used are fed by dumping from trucks, and full rigid enclosure is not possible; however dust hoods can be fitted to effectively achieve almost total enclosure.

圖三：初級碎石機的局部圍封

Figure 3: Partial enclosure for primary crusher

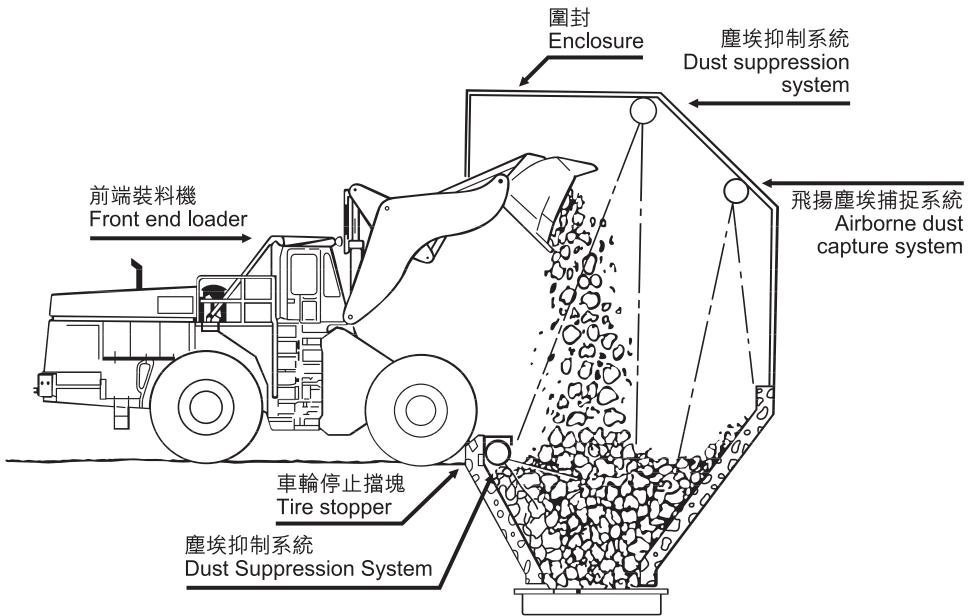

圖四：完全密封的次級碎石機

Figure 4: Full enclosure for a secondary crusher

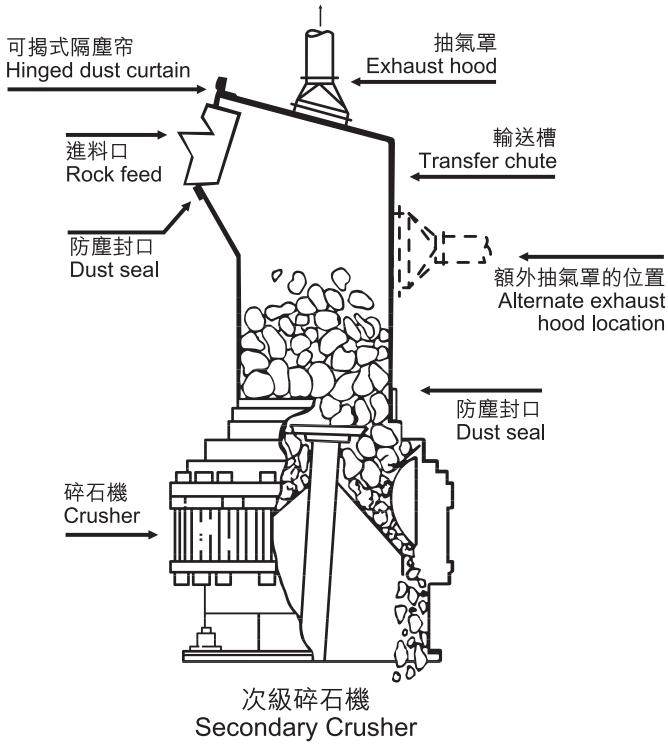

- 六 密封裝置須有良好設計，既能密封塵埃，亦易於拆除，以利維修。運作上，遇有密封性能轉差時，可增加空氣的抽出量去補救。

輸送帶

- 七 輸送帶的轉送點應加以圍封，並安裝抽氣設備，形成負壓，以控制塵埃洩漏。抽出的塵埃應以管道引至適當的集塵器。如採用洒水法，則可在輸送系統內每個轉送點安裝自動洒水器。洒水器可裝在上層輸送帶之上，以便在物料卸下前加以洒濕，及裝在物料送至下層輸送帶的地方，防止塵埃擴散。
- 八 如將物料卸落至開放之貯料堆，輸送帶的高度應盡可能可調校，以確保物料跌落的距離減到最低。
- 6 Encapsulation should be designed to give good sealing, although it should be readily removable for maintenance purpose. In practice less efficient sealing can be compensated by increasing the amount of air extracted.

Conveyors

- 7 Dust liberated at transfer points should be controlled by sheeting enclosure under a negative pressure connected by means of ducting to a suitable collector. If wet suppression is preferred, sprays can be automatically applied at each transfer point in the handling system. Sprays should be located at the head pulley to treat material prior to discharge and also at the point where material lands on the lower belt to prevent dust emission.
- 8 Conveyors discharging to open stockpiles shall be adjustable, where practicable to ensure minimum free fall distance.

圖五： 輸送帶轉送點的密封及塵埃抑制系統

Figure 5: Enclosure and dust suppression system for a conveyor transfer point

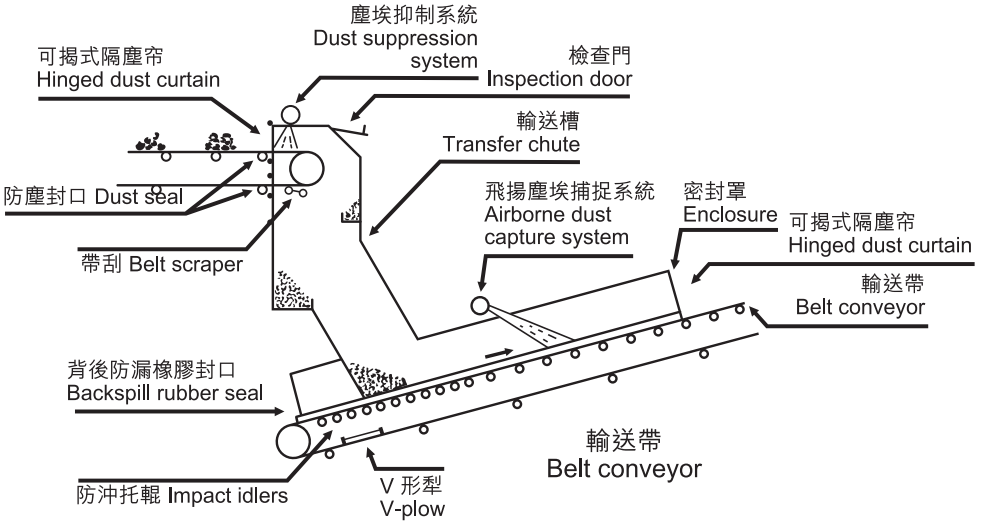

圖六： 可調校高低的輸送帶

Figure 6: An adjustable conveyor over an open stockpile

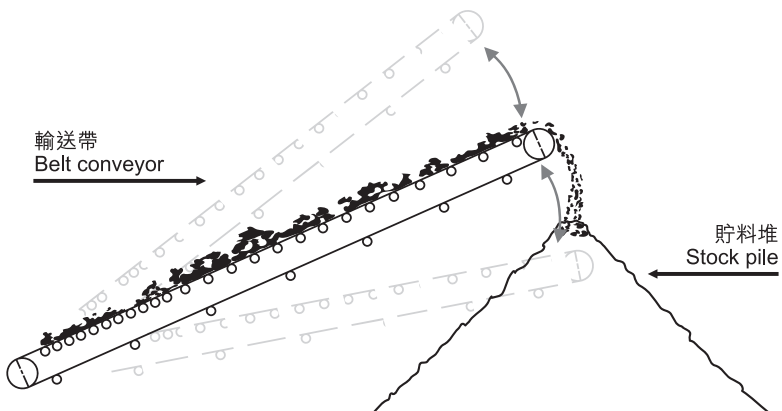

篩選

- 九 通常由抓斗或傾卸式貨車供應物料的初級篩選機，應安放在有蓋而三面圍封的建築物內，並最好用濕洒法去控制塵埃，因為即使過多水氣亦不會造成阻塞。如須在該處部署工作人員，則應架設一環境整潔的控制室。
- 十 使用次級篩選器時，宜用洒水系統。若由於操作上的原因不宜採用該系統，則可以考慮使用一堅固及易於拆除的蓋，並在濾網長度約三份一處附設一吸塵器。根據過往經驗，如要吸塵器取得滿意的效果，每平方米濾網地帶的抽取空氣率約為每分鐘二十五立方米。

Screening

- 9 For screening equipment with primary scalping duties, and generally with feeding by grab or dump truck, a roofed, 3-sided structure can be used and wet suppression is the best practicable means, as blinding by excess moisture does not constitute a problem. If it is necessary to have personnel deployed in the area, a control cabin with a controlled environment should be provided.
- 10 For secondary and selector screens, wet suppression systems may be used to advantage. If, for operating reasons this system is undesirable, a heavy duty, easily removable cover may be considered. A dust collector situated some one-third of the way down the screen's length can be incorporated. Experience has shown that extraction at the rate of approximately $25\text{m}^3/\text{min}/\text{m}^2$ of screen area is required for satisfactory collection.

- 十一 用以篩選產品的濾網須能從混合的物料中，正確選出指定大小的產品。如要篩選情況理想，則游離水份不應超過百份之三，這樣微粒才不會附在網上，阻塞網眼。因此，不能使用洒水法。在此情形下，最有效控制塵埃的方法就是將產品篩選器完全密封，這可採用鋼製固定裝置，或用橡膠或玻璃纖維製造的震動罩蓋。
- 十二 被篩進濾網底的細小物料會散落在料斗內，收集時會引起塵埃飛揚。為求減低塵埃量，應在震動網身與固定結構之間安裝卷曲橡膠，或安裝一伸縮幕覆蓋篩選箱直達料斗口之處。
- 11 For product screens which select accurately specific sizes from a blended feed, ideal screening conditions suggest that the free moisture should not exceed 3 per cent if "blinding" of the screen elements by adhering fines is to be eliminated. Therefore, wet suppression methods cannot be advocated. The most effective method of dust control for a product screen is complete encapsulation. This can be achieved by means of static steel assemblies, or covers which vibrate, perhaps manufactured from rubber or glass reinforced plastic.
- 12 The dust generated from the collection of undersize material from a screen into a hopper located immediately beneath the screen may be reduced by the use of convoluted rubber fixed between the vibrating screen body and the static structure, or alternatively having a flexible curtain which protrudes from the screen box into the hopper mouth.

圖七： 震動篩選機的密封及塵埃收集系統

Figure 7: Enclosure and dust collection system for a vibrating screen

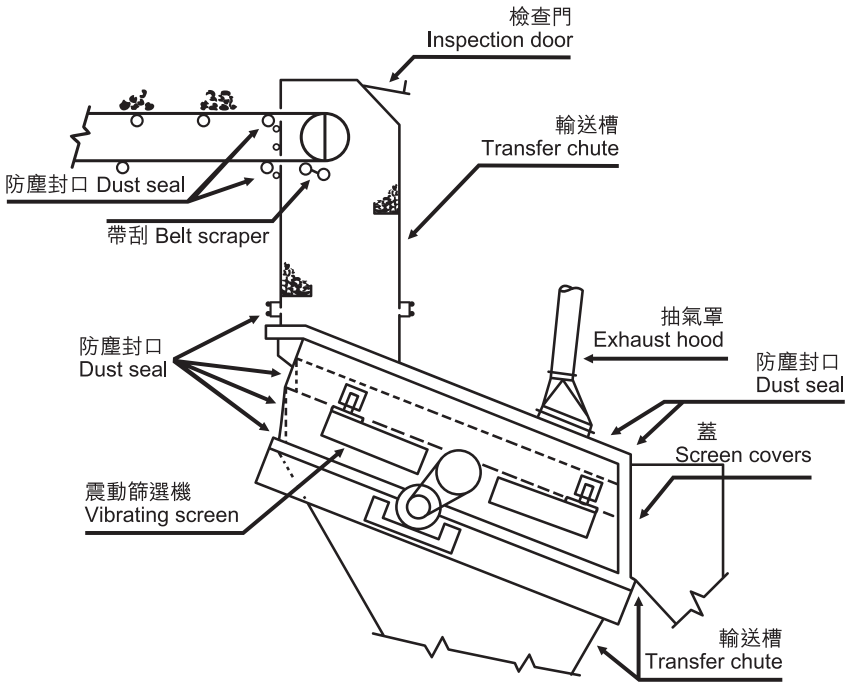

貯料堆

- 十三 由於太陽及風吹原因，運送碎石往貯料堆的輸送帶頭往往會釋出大量塵埃。這種情況可採用以下方法改善：
- (甲) 將貯料堆和有關輸送帶完全封閉；
 - (乙) 部份封閉，例如建築混凝土或木牆，將物料置於二、三或四道牆之間。隔牆必須較貯料堆為高，使其間空氣靜止，以減低塵埃的散佈；
 - (丙) 在輸送帶頭或貯料堆週圍裝設洒水器，位置及數量視乎貯料堆的大小而定；
 - (丁) 提供方法，調整運送貯料之輸送帶的高度。
- 十四 如輸送帶不能調整，應在貯料堆與輸送帶之間設置一可伸縮的斜槽，避免在傳輸時產生塵埃。

Stockpiles

- 13 Excessive dust emission due to sun and wind action occurring particularly at the head of a conveyor feeding a stockpile can be limited by:-
- (a) Total enclosure of the stockpile and the conveyor belt feeding the stockpile;
 - (b) Partial enclosure e.g. walls of concrete or timber erected to contain the material between 2, 3 or 4 walls. The dividing walls must extend above the stockpiles to get still air conditions over the stockpile and reduce dust emission;
 - (c) Locating water sprays at the head of the conveyor or around the perimeter of the stockpile depending upon the size of the stockpile;
 - (d) Providing a means of adjusting the height of the stockpiling conveyor.
- 14 Telescopic chutes should be provided between stockpiles and conveyors if the conveyors are not adjustable to avoid airborne dust during transfer.

圖八：貯料堆上的伸縮槽

Figure 8: A telescopic chute over an open stockpile

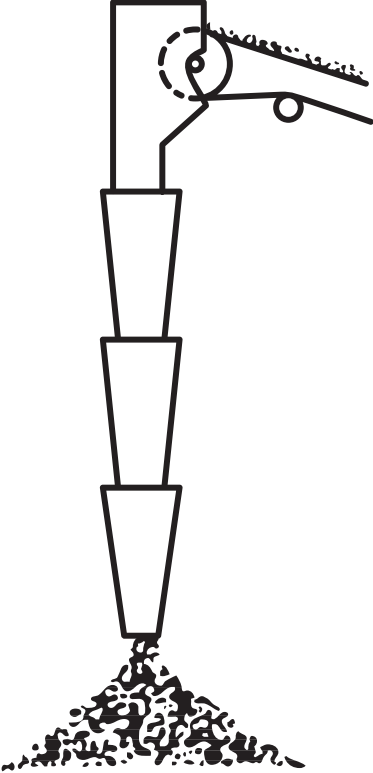

運載及道路

十五 車輛裝料時，可用以下方法減低塵埃的散佈：

- (甲) 裝料處宜加以圍封，並保持負壓，防止塵埃洩出。抽出的塵埃經由一適當的集塵器收集；
- (乙) 在物料裝上車輛前，先以水和潤濕劑噴洒。

十六 運載途中，無篷車輛上的物料應用防水布鋪蓋，或在石料面洒水。

Transport and Roads

15 During vehicle loading, dust emission can be reduced by:

- (a) Enclosure of filling station with a light structure and providing a negative pressure within the enclosure to prevent dust escaping to the atmosphere. Air extracted is debusted by means of a suitable collector;
- (b) Treating the material prior to vehicle loading with water and wetting agent sprays.

16 During transport, the material on open vehicles should be sheeted down with suitable tarpauline. Alternatively, the top surface of the aggregates should be treated with water spray.

圖九： 圍封裝料處

Figure 9: Enclosure of a loading station

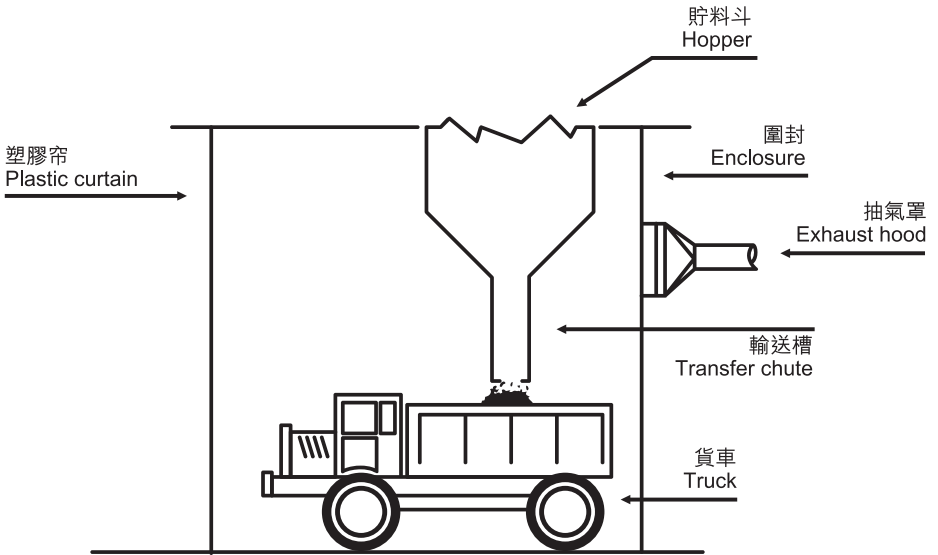

十七 路上因風或車輛行駛時揚起的塵埃，可用以下方法減至最低：

- (甲) 路面應堅固及防水。此外，應經常清掃路面，並在路面洒水，減少塵埃散佈；
- (乙) 運送貯料的道路可用水車不斷洒水或採用固定噴洒器，或使用氯化鈣保持地面的濕氣；
- (丙) 限制車速，及祇准車輛在指定的道路行走。

十八 貨車排氣管的出口應向上，以避免行走時揚起塵埃。

十九 在石壙場的車輛出口設置洗車輪的水槽。

- 17 Dusts stirred up on roads by winds or vehicle movements can be minimised by: -
- (a) Providing a hard, impervious road surface. These should be kept clean with a sweeper and damped down with water spray;
 - (b) Haul roads may be treated with continuous applications of water by water bowsers or permanent sprays, or with calcium chloride, which absorb moisture from the atmosphere;
 - (c) Restricting vehicle speeds and confining vehicles to designated roadways.
- 18 Outlet of the exhaust tailpipe for trucks should be directed upward to avoid stirring up of dust while moving.
- 19 Wheel-wash trough should be constructed at the vehicle exit of the quarry.

妥善的廠房管理

- 二十 當表土和植物被移去後，地面的塵埃會被吹起。因為泥土表面的濕氣通常靠植物保留下來，一旦除去植物，這層濕氣便被蒸發。最佳辦法就是盡快以草、灌木、樹等代替原來植物，或在地面洒水，或用橡漿，乙烯基或瀝青封蓋。
- 二十一 良好的廠房管理及保養是減少塵埃的要素。

Good Housekeeping

- 20 When soil and vegetable has been removed, dust will be blown from the surface because the moisture normally held in the surface by the vegetable is allowed to evaporate. The best treatment is to replace the vegetable as soon as possible with grass, shrubs, trees, etc. Alternatively the surface can be treated by applying a water spray or sealing with latex, vinyl or bitumen.
- 21 A high standard of housekeeping and maintenance is required to minimise dust levels.

進一步資料

如擬索取進一步資料或尋求協助，請與勞工處職業安全及健康部聯絡。

地 址： 香港中環統一碼頭道 38 號
海港政府大樓 15 字樓

電 話： 2852 4041

傳 真： 2581 2049

網 址： <http://www.info.gov.hk/labour>

電子郵件： laboureq@labour.gcn.gov.hk

Further Information

For further information about the subject or assistance, please contact

Occupational Safety and Health Branch

Labour Department

Address: 15/F, Harbour Building
38 Pier Road, Central
Hong Kong

Tel: 2852 4041

Fax: 2581 2049

Home Page address : <http://www.info.gov.hk/labour>

E-mail address : laboureq@labour.gcn.gov.hk



勞工處
職業安全及健康部
Occupational Safety and Health Branch
Labour Department